

# Summer Scottish Country Dancers - Edinburgh - 27 May 2025

## Fairmilehead Church Hall, Frogston Avenue

### 1 THE HAPPY MEETING J32 · 2/4L

RSCDS XXIX 9 · Crib: MiniCribbs · Diagram: Keith Rose's Diagrams

- 1-8 1M+2L cross passing RSh, dance LSh round partner, pass RSh up/down & dance RSh round standing Man/Lady (1M round 2M, 2L round 1L)
- 9-16 1L+2M cross passing LSh, dance RSh round partner, pass LSh up/down & dance LSh round standing Man/Lady (2M round 1M, 1L round 2L)
- 17-24 1s dance 4 slip step down middle, set to each other, slip step up to top & cast to 2nd place
- 25-32 2s+1s Adv+Ret clapping on bar 28 & turn partners RH

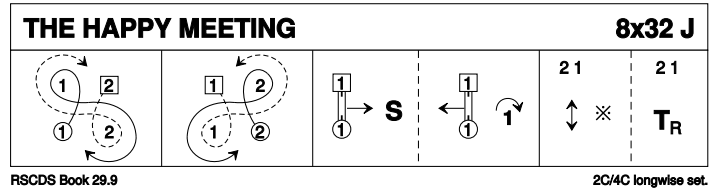

### 2 ROUND REEL OF EIGHT R88 · 4S

RSCDS XXVII 7 · Crib: MiniCribbs · Diagram: Keith Rose's Diagrams

- 1-16 All Ladies cast & dance clockwise round outside of set back to place, Men repeat Fig but cast & dance anticlockwise round set
- 17-32 All dance Grand Chain 1/2 way (6 bars) & set to partner, continue Chain back to place (6 bars) & set to partner
- 33-40 1s+3s change places, 1s dancing between 3s (3 bars), repeat back to places, 3s dancing between 1s, 1s+3s turn RH into Allemande hold
- 41-48 1s+3s dance round inside of set anticlockwise in Allemande hold
- 49-64 2s+4s repeat Fig bars 33-48 with 2s dancing between 4s to start
- 65-88 1s+3s dance 1/2 R&L, 2s+4s dance 1/2 R&L, repeat back to places, all circle 8H round & back

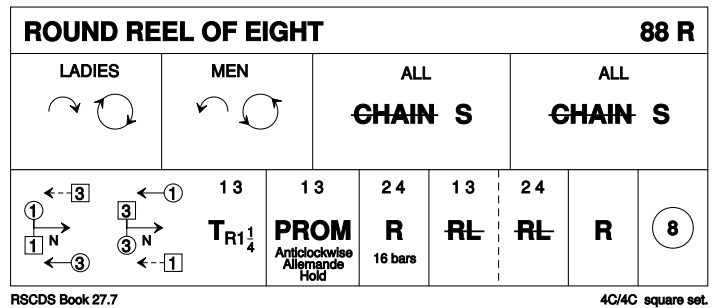

### 3 THE MINISTER ON THE LOCH S32 · 3/3L

Roy Goldring: Magazine Dances 2005-2009 · Crib: MiniCribbs · Diagram: Keith Rose's Diagrams

- 1-8 1s+2s dance Diamond Poussette
- 9-16 1s dance down for 2 steps, turn 2H, dance up to top & turn 2H remaining in centre facing up
- 17-24 1s+3s dance double Fig of 8 round 2s with 1s casting to start
- 25-32 1M+2M turn LH 1.1/2 times while 1L+2L turn RH 1.1/2 times, 1M+3M turn RH 1.1/2 times while 1L+3L turn LH 1.1/2 times

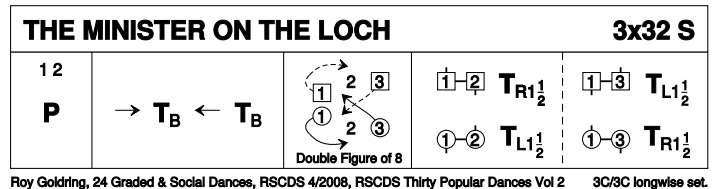

### 4 PORTNACRAIG R32 · 3/4L

Linda C Gaul: RSCDS XXXVI 1 · Crib: MiniCribbs · Diagram: Keith Rose's Diagrams

- 1-8 1s set & 1/2 turn 2H to face 2s, set & 1/2 turn 2s (1M+2L turn RH, 1L+2M turn LH) to end in 2nd place on opposite sides. 2 (1) 3
- 9-16 2s+1s+3s Adv+Ret 2 steps & circle 6H round 1/2 way to left. (3) 1 (2)
- 17-24 1s pass LSh, dance 1/2 RSh reels of 4 with 1st corners; pass LSh, dance 1/2 RSh reel of 4 with 2nd corners, end in 2nd place opp sides. 2 (1) 3
- 25-32 1s dance 1/2 Fig of 8 round 3s & 2s+1s+3s turn RH

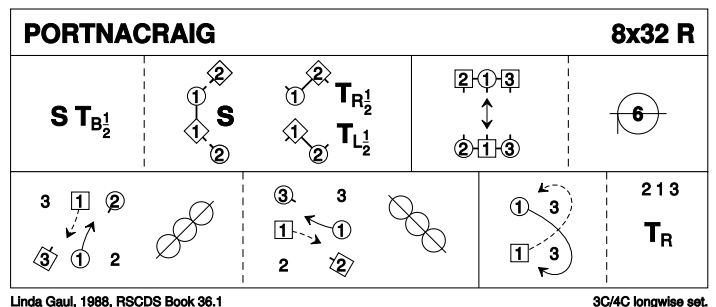

**5 A CAPITAL JIG** J32 · 3/4L

*Tine E Mackay: Magazine Dances 2005-2009 · Crib: MiniCribs · Diagram: Keith Rose's Diagrams*

- 1-8 1s+2s Set & Rotate & end 1s facing up, 2s down:  
Set, rotate singly & dance on 1 place clockwise, change places RH on sides & dance on 1 place to own sides (1s in 2nd place facing up)
- 9-16 1s dance reels of 3 on own sides (RSh to 2s)
- 17-24 1s set & turn 3/4 RH to face own sides, 1s dance LH across (1L with 2s, 1M with 3s) to end 2nd place opposite sides
- 25-32 1s set & turn 3/4 RH to face opposite sides, 1s dance LH across (1M with 2s, 1L with 3s) ending 2nd place own sides

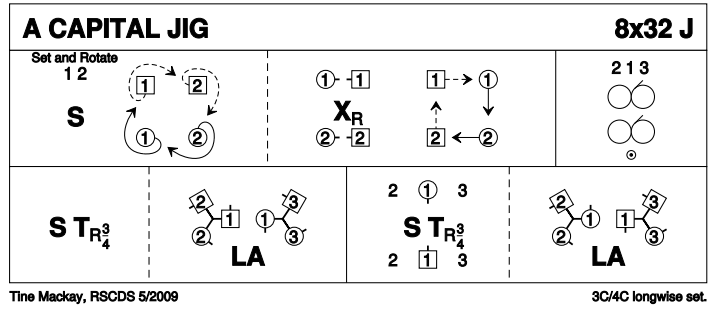

**6 THE ROBERTSON RANT** S80 · 4S

*Mrs Douglas Winchester: RSCDS XXXIX 8 · Crib: MiniCribs · Diagram: Keith Rose's Diagrams*

- 1-8 All circle 8H round & back
- 9-16 All Ladies dance RH across 1/2 way & turn opposite Man LH, all Ladies dance 1/2 RH across & turn partner LH
- 17-24 1s+3s dance reel of 4 (Ladies start by passing LSh as Men set)
- 25-32 All set (HS) to corners, turn 2H twice
- 33-40 2s+4s dance reel of 4 (Ladies start by passing LSh as Men set)
- 41-48 All set (HS) to corners, turn 2H twice
- 49-56 All Ladies circle left to face partners (Ladies BtoB), set to & turn partners 2H
- 57-64 All Men circle right to face partners (Men BtoB), set to & turn partners 2H
- 65-72 All dance Grand Chain
- 73-80 All take allemande hold & dance anticlockwise once round set, bringing Ladies into centre for bow/curtsey

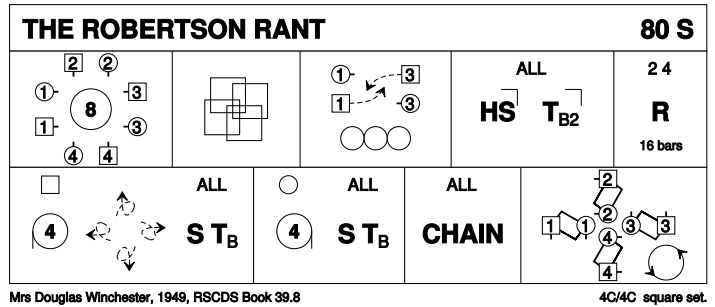

**7 THE SALTIRE SOCIETY REEL** R32 · 3/4L

*Roy Goldring: The Leaflet Dances with Music · Crib: MiniCribs · Diagram: Keith Rose's Diagrams*

- 1-8 1s cross down & dance out between 2s+3s turning 3s by near hand to meet ptnr, dance up & turn 2s by nearest hand to 2nd place opp sides
- 9-16 1s cross down to 3rd pl & dance reel of 3 own side (2s dance out/down as 3s dance out/up b'tw'n 2s), 1s end (hold LH) facing 1st crnrs
- 17-24 1s set to 1st crnrs, turn inwards & set to 3rd corner as 3rd crnrs set adv to dance RH across with 1s, 1s end turning to face 2nd crnrs
- 25-32 1s repeat bars 17-24 with 2nd/4th corners but dancing LH across

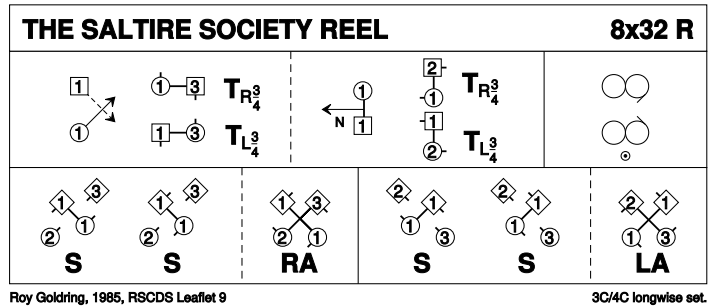

**8 THE FRISKY** J32 · 3/4L

*Robert Bremner: RSCDS XXVI 10 · Crib: MiniCribs · Diagram: Keith Rose's Diagrams*

- 1-8 1s turn RH & cast 1 place, turn LH & cast down 1 place
- 9-16 2s+3s+1s circle 6H round & back
- 17-24 1s lead up to top & 1s+2s set twice
- 25-32 1s+2s dance 1/2 R&L, set & cross RH to own sides

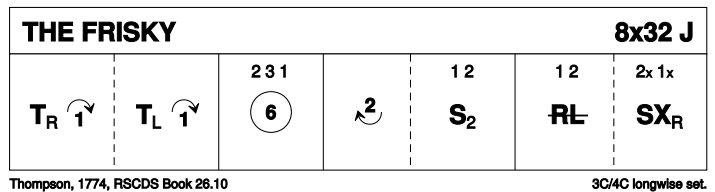

**9 CITY OF BELFAST S32 · 3/3L**

*Lucy Mulholland: RSCDS XLVIII 6 · Crib: MiniCribs · Diagram: Keith Rose's Diagrams*

- 1-8** 1s dance 1/2 Fig of 8 round 2s, 1L+2M turn RH 1.1/4 times **while** 1M+2L turn LH 1.1/4 times & 1s end BtoB facing opp sides
- 9-16** 1s+2s dance reel of 4 across in 2nd place. 2s end in 1st places **while** 1s pass LSh to face 1st corners
- 17-24** 1s set to 1st corner & 2nd corner ending (turning to right) between corners, all set & 1s cross RH
- 25-32** 1s+3s dance Espagnole:  
**25-26** 1s+3s cross (Ladies lead across RH passing between Men) with Ladies changing places RH  
**27-28** 1s+3s cross back (Men lead across RH between Ladies) with Men changing places RH  
**29-32** 3s turn RH as 1s turn LH to end 2 3 1

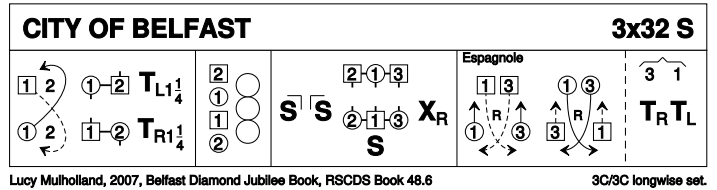

**10 THE BLACK MOUNTAIN REEL R32 · 5/5L**

*Derek Haynes: Thirty Popular Dances, Volume Two · Crib: MiniCribs · Diagram: Keith Rose's Diagrams*

- 1-8** 1s & 3s cross RH & cast down 1 place, dance 1/2 Fig of 8 round the couples above them & cross to face 1st corners
- 9-16** 1s & 3s turn 1st corners RH & partner LH, turn 2nd corner RH & partner LH to face 1st corners again
- 17-24** 1s & 3s dance full diagonal reels of 4 with 1st corners
- 25-32** All dance RH across once round (1L with 2s, 1M+3L with 4s & 3M with 5s), 1s & 3s turn ptnrs LH & cast one place. 2 4 1 5 3

